

Feature

- Chips are electrically insulated from plate
- Package in compliance with international standard. Pressure type, excellent temperature characteristics and power cycling capability
- 350A below modules are forced air cooling, 400A above modules can be selected by air cooling or water cooling

$I_{T(AV)}$	55A
V_{DRM}/V_{RRM}	500-2500V
I_{TSM}	1.25 KA
I^2t	7.8 $10^3 a^2 s$

Typical application

- AC, DC motor control, Different kind of rectifying power supply
- Industrial heating and control, Light adjustment, Non-contact switch
- Motor softstarter, Static reactive power compensation
- Welding equipment, Frequency transformer, UPS, Battery charging and discharging

SYMBOL	CHARACTERISTIC	TEST CONDITIONS	T_J (°C)	VALUE		UNIT
				Min	Max	
$I_{T(AV)}$	Mean on-state current	180° half sine wave, 50HZ Double side cooled, $T_C=98^\circ C$	125		55	A
$I_{T(RMS)}$	RMS current		125		86	A
V_{DRM} V_{RRM}	Repetitive peak off-state voltage Repetitive peak reverse voltage	$V_{DRM} \& V_{RRM} t_p=10ms$ $V_{DSM} \& V_{RSM}=V_{DRM} \& V_{RRM}+200V$	125	500	2500	V
I_{DRM} I_{RRM}	Repetitive peak current	$V_{DM}=V_{DRM}$ $V_{RM}=V_{RRM}$	125		8	mA
I_{TSM}	Surge on-state current	10ms half sine wave	125		1.25	KA
I^2t	I^2t for fusing coordination	$V_R=0.6V_{RRM}$			7.80	$A^2s \times 10$
V_{TO}	Threshold voltage		125		0.85	V
r_T	On-state slope resistance				3.47	mΩ
V_{TM}	Peak on-state voltage	$I_{TM}=170A$	25		1.10	V
dv/dt	Critical rate of rise of-state voltage	$V_{DM}=0.67V_{DRM}$	125		800	V/us
di/dt	Critical rate of rise of on-state current	$V_{DM}=67\% V_{DRM}$ TO 1000A, Gate pulse $t_r \leq 0.5us$ $I_{GM}=1.5A$	125		50	A/us
I_{GT}	Gate trigger current	$V_A=12V, I_A=1A$	25	30	100	mA
V_{GT}	Gate trigger voltage			0.8	2.5	V
I_H	Holding current			20	150	mA
V_{GD}	Npn-trigger gate voltage	$V_{DM}=0.67V_{DRM}$	125	0.2		V
$R_{th(j-c)}$	Thermal impedance node to the shell	180° sine wave, single heat sink			0.530	°C/W
$R_{th(c-h)}$	Thermal impedance (shell to powder)	180° sine wave, single heat sink			0.2	°C/W
V_{iso}	Insulation voltage			2500		V
F_M	Mounting force (M5)				4	N-m
	Mounting force (M6)				6	N-m
T_{stq}	Stored temperature			-40	125	°C
W_t	Weight					g
Outline						

Peak On-state Voltage Vs. Peak On-state Current

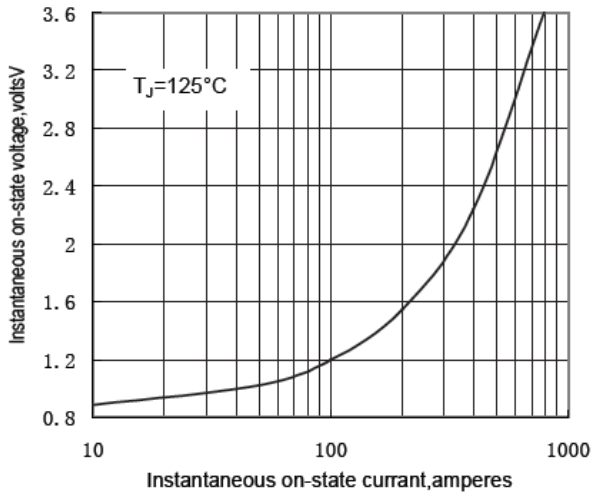

Fig.1

Max. junction To case Thermal Impedance Vs. Time

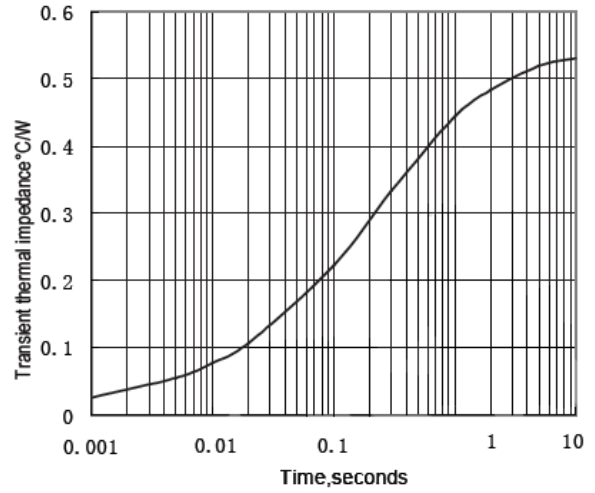

Fig.2

Max. Power Dissipation Vs. Mean On-state Current

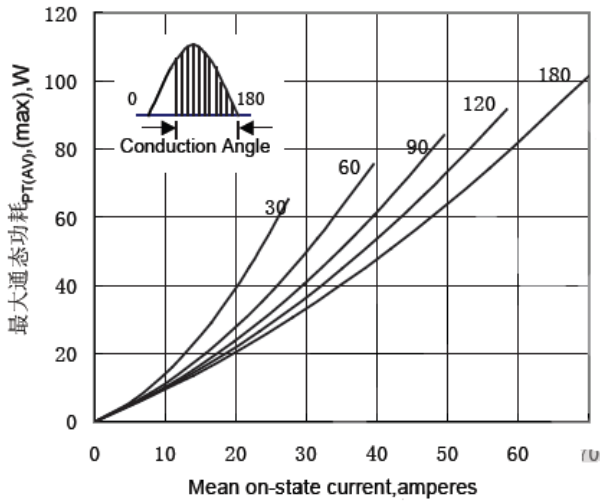

Fig.3

Max. heatsink Temperature Vs. Mean On-state Current

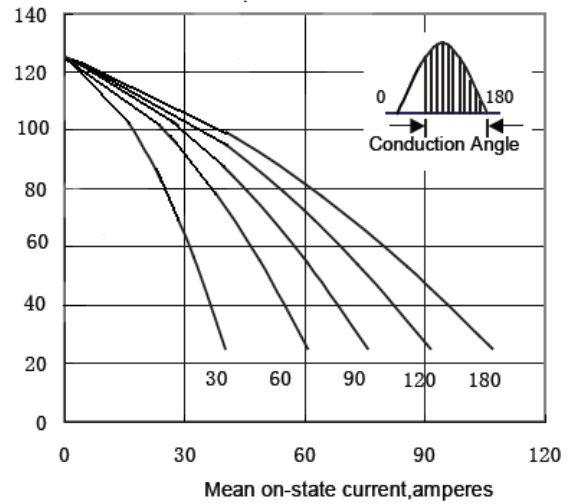

Fig.4

Max. Power Dissipation Vs. Mean On-state Current

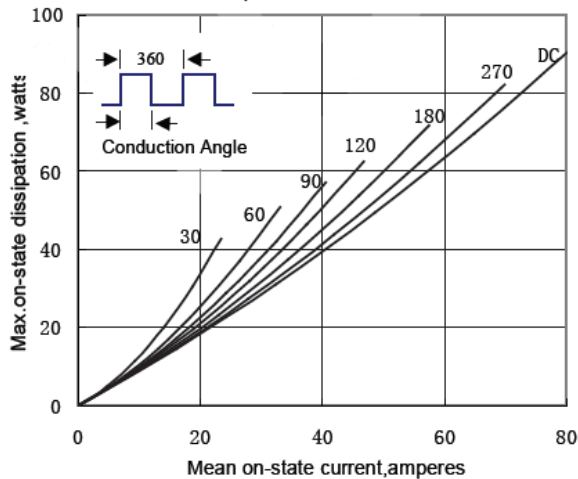

Fig.5

Max. case Temperature Vs. Mean On-state Current

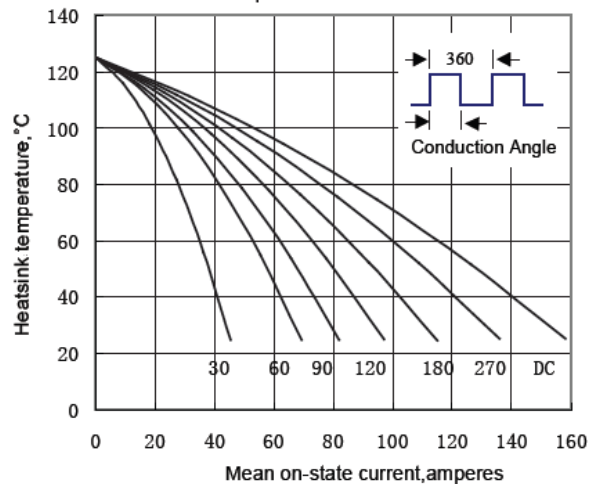
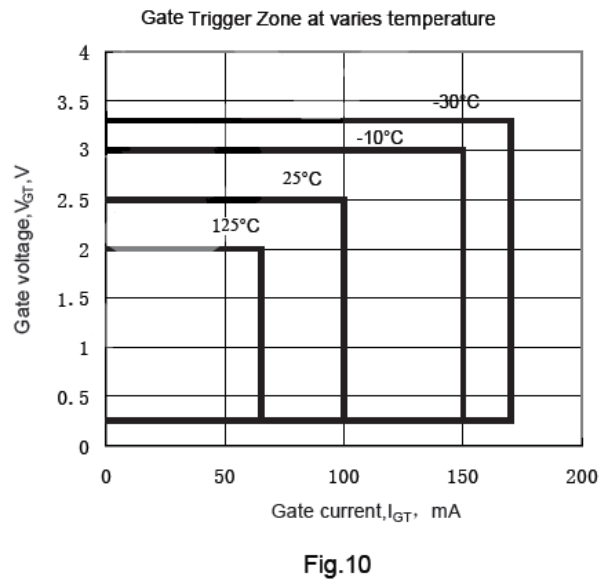
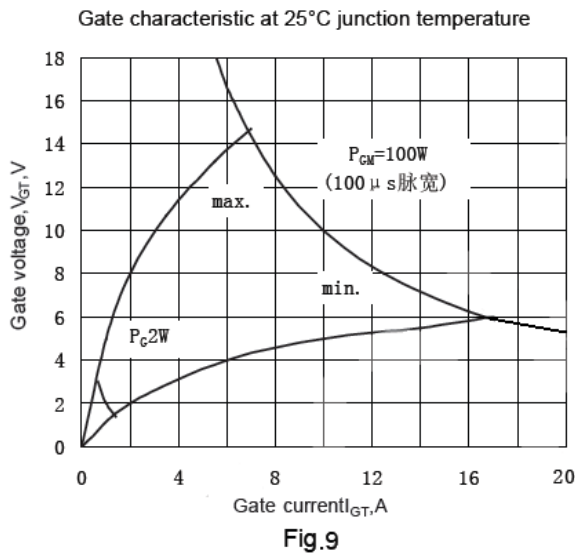
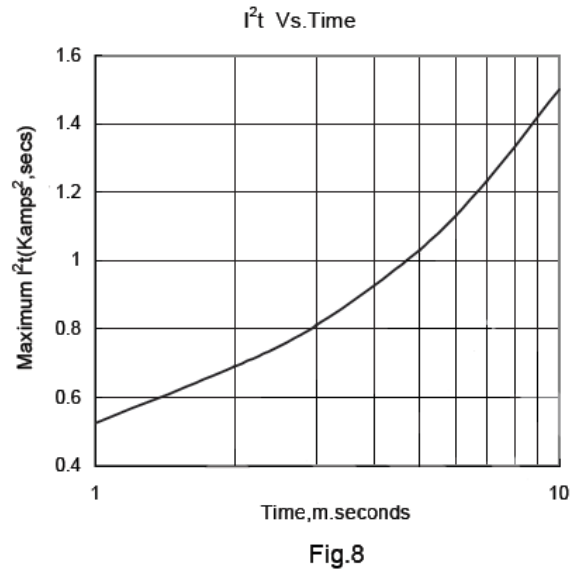
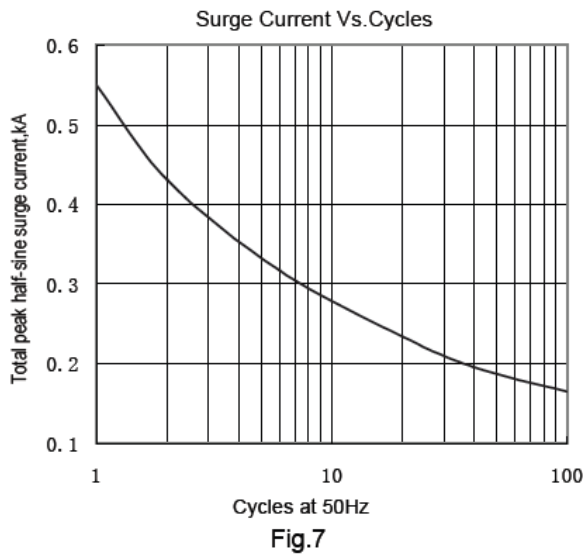
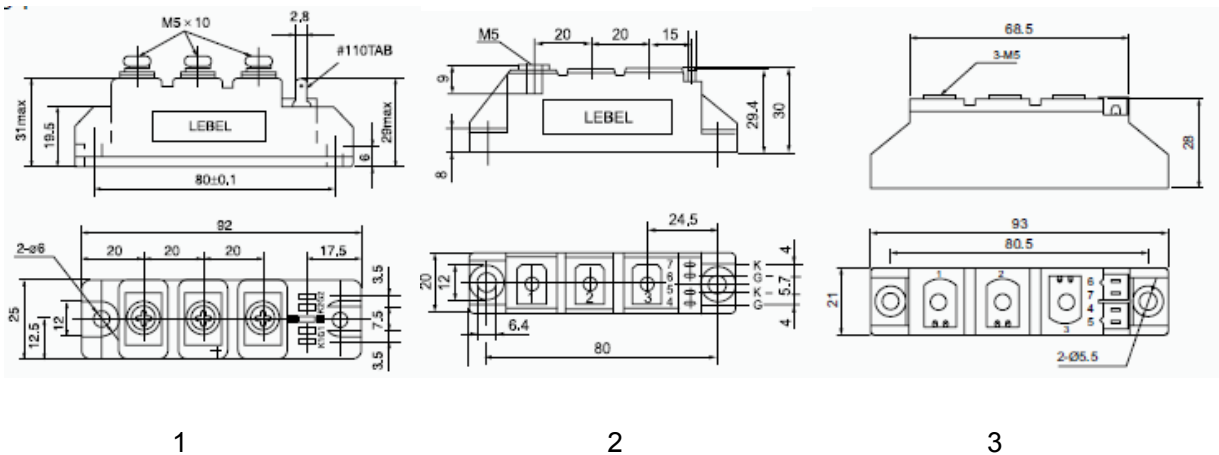

Fig.6



Outline:



Circuit Drawing:

